

Customer Experience Center
1-800-331-4331

www.toyotaownersonline.com



moving forward ▶

SIENNA



2006
Pocket Reference Guide

MN 00452-PRG06-SIE
Printed in USA 08/05

2006 Sienna

This *Pocket Reference Guide* is a summary of basic vehicle operations. It contains brief descriptions of fundamental operations so you can locate and use the vehicle's main equipment quickly and easily.

The *Pocket Reference Guide* is not intended as a substitute for the *Owner's Manual* located in the vehicle's glove box. We strongly encourage you to review the *Owner's Manual* and supplementary manuals so you will have a better understanding of the vehicle's capabilities and limitations.

Your dealership and the entire staff of Toyota Motor Sales, U.S.A., Inc., wish you many years of satisfied driving in your new Sienna.

! A word about safe vehicle operations

This *Pocket Reference Guide* is not a full description of Sienna operations. Every Sienna owner should review the *Owner's Manual* that accompanies this vehicle.

Pay special attention to the boxed "**⚠CAUTION**" information highlighted throughout this reference guide and throughout the *Owner's Manual*. Each box contains safe operating instructions to help you avoid injury or equipment malfunction.

All information in this *Pocket Reference Guide* is current at the time of printing. Toyota reserves the right to make changes at any time without notice.

Spare tire & tools

Tool and spare tire location

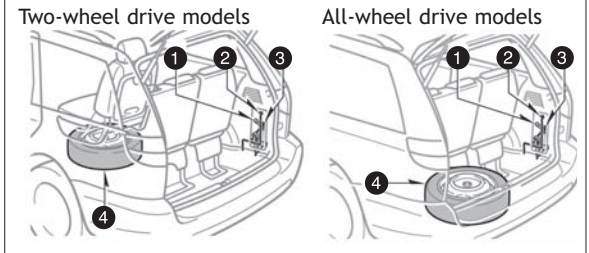

- 1 Wheel nut wrench
- 2 Jack handle
- 3 Jack
- 4 Spare tire

Removing the spare tire (two-wheel drive models)

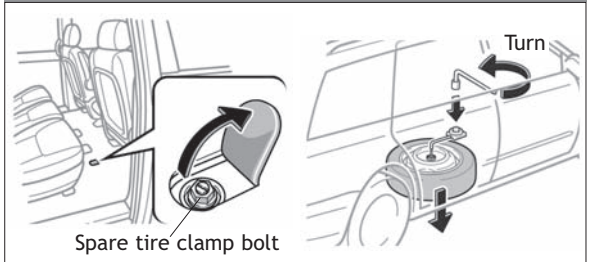

Removing the spare tire (all-wheel drive models)

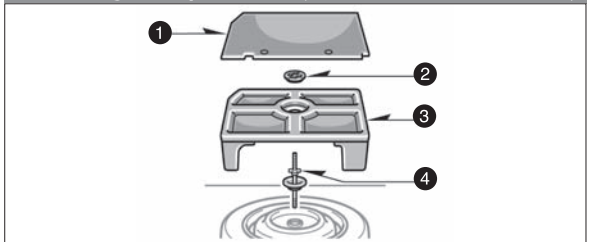

- 1 Remove the floor panel.
- 2 Loosen and remove the nut.
- 3 Remove the spare tire cover.
- 4 Loosen and remove bolt with spacer.

Refer to the *Owner's Manual* for jack positioning and tire changing procedures.

INDEX

Item	Page no.
OVERVIEW	
Engine maintenance	7
Fuel tank door release and cap	7
Hood release	6
Indicator symbols	4-5
Instrument cluster	4
Instrument panel	2-3
Keyless entry	6
FEATURES/OPERATIONS	
Air conditioning/Heating	22-23
Audio	20-21
Auto lock function¹	8
Automatic transmission	8
Bottle holders	25
Clock	13
Console box	13
Cruise control	18
Cup holders	26
Door-Power back	12
Doors-Power sliding	12
Dynamic laser cruise control	18-19
Front seat console table	13
Light control-Instrument panel	19
Lights & turn signals	9
Moonroof	11
Multi-Information display (HomeLink®) ²	24
Parking brake	10
Power outlets	25
Rear seat entertainment system	24
Seat adjustments-Front	14
Seat adjustments-Rear	14
Seat arrangements	15
Seat heaters	11
Seats-Head restraints	15
Seats-Stowing third row seats	16-17
Seats-Tumble/Remove second row seats	16
Sunshade-Side	17
Tilt and telescopic steering wheel	8
Windows	11
Window-Power quarter	10
Window wiper & washer	10
SAFETY AND EMERGENCY FEATURES	
Door locks	27
Doors-Child safety locks	27
Seat belt comfort guide	27
Seat belts	28
Seat belts-Shoulder belt anchor	27
Spare tire & tools	29
Tire Pressure Warning System reset	28

OVERVIEW

FEATURES/OPERATIONS

SAFETY AND EMERGENCY FEATURES

¹ Programmable by customer. For other dealer-programmable features, please visit your Toyota dealer.

² HomeLink® is a registered trademark of Johnson Controls, Inc.

OVERVIEW

Instrument panel

Overhead console

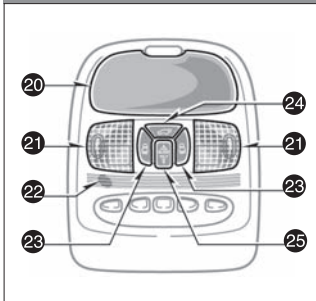

Steering wheel switches

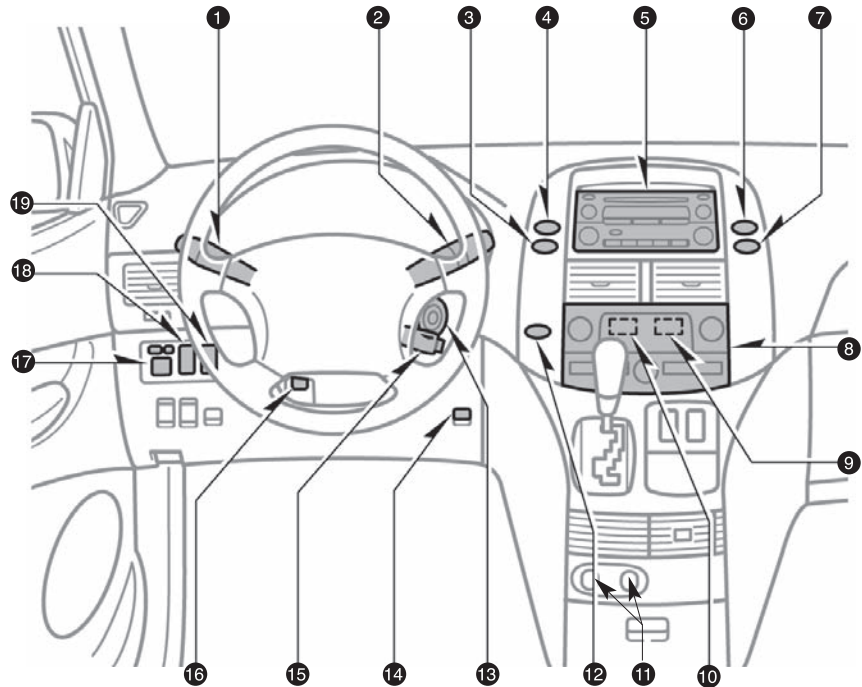
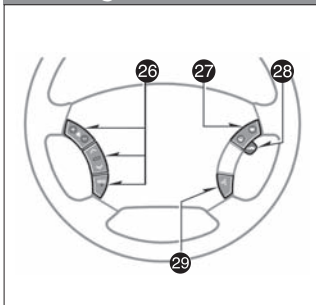

- ❶ Headlight, turn signal and front fog light¹ controls
- ❷ Wiper and washer controls
- ❸ Rear window and outside rearview mirror defogger¹ and windshield wiper de-icer¹ switch
- ❹ Emergency flasher
- ❺ Audio or navigation system^{1,2}
- ❻ 115V AC Power outlet ON/OFF switch¹
- ❼ AUX adapter
- ❽ Front air conditioning controls
- ❾ Front passenger occupant classification indicator
- ❿ Toyota park assist system and indicator¹
- ⓫ 12V DC Power outlet
- ⓬ Personal light main switch
- ⓭ Ignition
- ⓮ "TRAC OFF" (Traction Control "OFF")¹
- ⓯ Cruise control or dynamic laser cruise control¹

- ⓶ Tilt and telescopic steering lock release
- ⓷ Power rearview mirror controls
- ⓸ Power quarter window switch¹
- ⓹ Headlight beam level control dial¹
- ⓺ Conversation mirror
- ⓻ Front personal lights
- ⓼ Microphone^{1,2}
- ⓽ Power sliding door switch¹
- ⓾ Power back door switch¹
- ⓿ Electric moon roof switch¹
- ⓿ Audio steering wheel switches^{1,2}
- ⓿ Telephone switch^{1,2}
- ⓿ Dynamic laser cruise control distance switch¹
- ⓿ Speech command switch^{1,2}

¹ If equipped

² For details, refer to the *Navigation System Owner's Manual*.

Instrument cluster

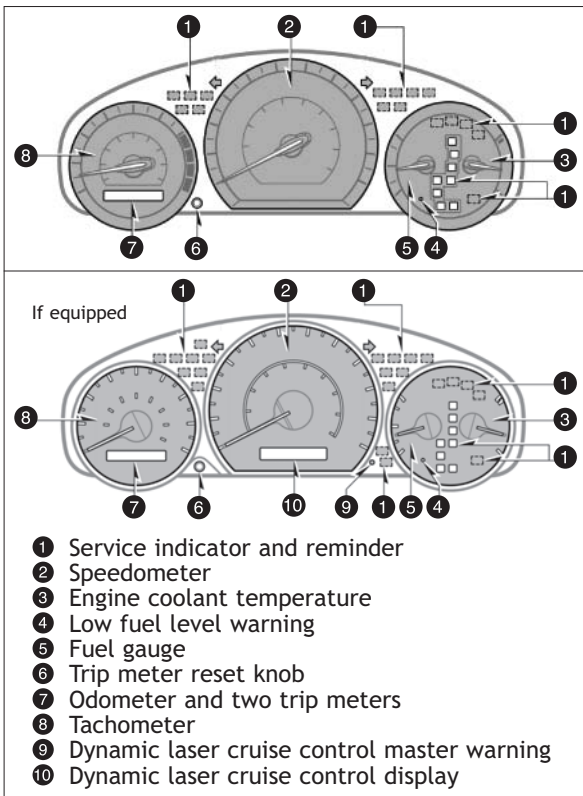

Indicator symbols

	Brake system warning ¹
	Driver's seat belt reminder ¹
	Front passenger's seat belt reminder ¹
	Battery warning ¹
	Malfunction indicator/Check engine ¹
	Low engine oil pressure warning ¹

¹ For details, refer to "Service reminder indicators and warning buzzers," Section 1-6, 2006 Owner's Manual.

² If this light flashes, refer to "Cruise control," Section 1-7, 2006 Owner's Manual.

	Open door warning ¹
	Airbag SRS warning ¹
	Vehicle Stability Control/Traction Control warning ¹
	Low Tire Pressure Warning ¹
	Low windshield washer fluid level warning ¹
	Engine oil replacement reminder ¹
	Third seat fold incomplete warning ¹
	Engine immobilizer/Theft deterrent system indicator
	"AIRBAG ON" indicator
	"AIRBAG OFF" indicator
	Headlight low beam indicator
	Headlight high beam indicator
	Turn signal indicator
	Automatic transmission indicator
	Slip indicator
	Traction Control "OFF" indicator
	Cruise control indicator ² or dynamic laser cruise control indicator ³
	Dynamic laser cruise control ready mode indicator
	Conventional cruise control mode indicator
	Anti-lock Brake System warning ¹

CAUTION

When the Anti-lock Brake System (ABS) function is in action, you may feel the brake pedal pulsating and hear a noise. In this situation, to let the Anti-lock Brake System work for you, just hold the brake pedal down more firmly. Do not pump the brake as this will result in reduced braking performance.

³ If this light flashes, refer to "Dynamic laser cruise control," Section 1-7, 2006 Owner's Manual.

Keyless entry

Locking operation

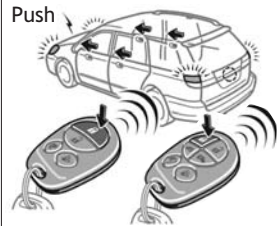

Unlocking operation

Push ONCE: Driver door
TWICE: ALL doors



NOTE: After unlocking, if a door is not opened within thirty (30) seconds, all doors will relock for safety.

Power sliding door operation (if equipped)

Right side power sliding door



Left side power sliding door



Power back door operation (if equipped)

Push and hold



Alarm operation

Push



Hood release

Pull

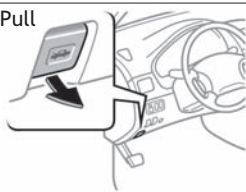

Pull up to release
then raise hood

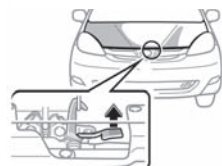

Fuel tank door release and cap

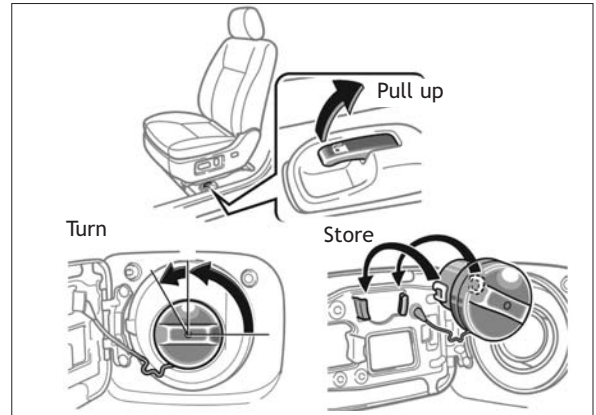

NOTE: If not tightened enough, Check Engine "CHECK" indicator may illuminate.

Engine maintenance

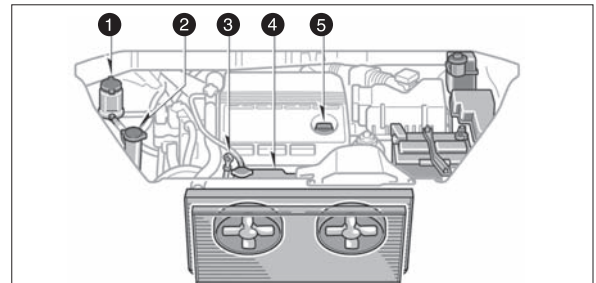

- 1 Power steering fluid reservoir
- 2 Windshield and rear window washer fluid tank
- 3 Engine oil level dipstick
- 4 Engine coolant reservoir
- 5 Engine oil filler cap

Note: Regularly scheduled maintenance, including oil changes, will help extend the life of your vehicle and maintain performance. Please refer to the "Owner's Warranty Information Booklet," "Scheduled Maintenance Guide" or "Owner's Manual Supplement."

FEATURES/OPERATIONS

Auto lock functions

Automatic door locks can be programmed by consumer to operate in 4 different modes.

- Doors lock when shifting from Park.
- Doors lock when the vehicle speed goes above about 12 mph.
- Doors unlock when the ignition key is turned to the "ACC" or "LOCK" position and driver's door is opened.
- Doors unlock when shifting into Park.

Tilt and telescopic steering wheel

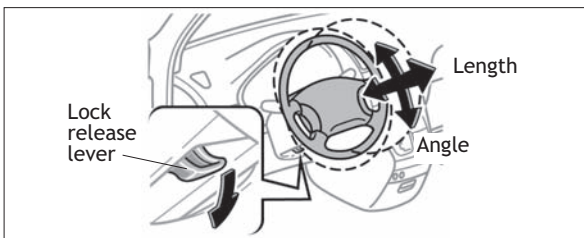

Hold wheel, push lever down, set angle and length, then return lever.

Note: Do not attempt to adjust while the vehicle is in motion.

Automatic transmission

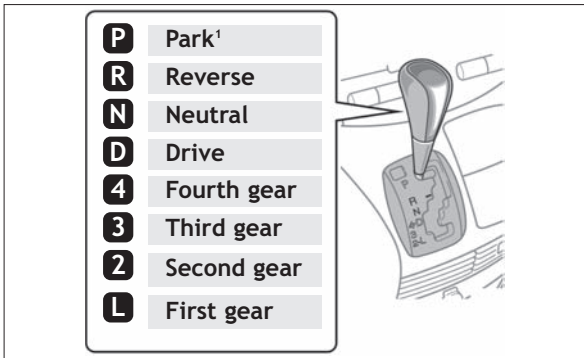

¹To shift from PARK, the key must be in the "ON" position, and the brake pedal depressed.

Downshifting increases power going uphill, or provides engine braking going downhill. For best fuel economy during normal driving conditions, always drive with the shift lever in the "D" position.

Lights & turn signals

Headlights

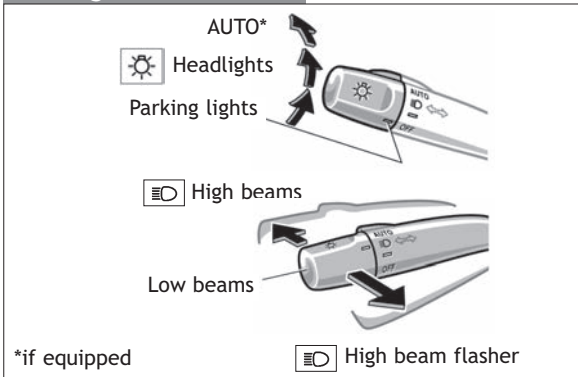

*if equipped

-Automatic light cutoff system Automatically turns lights off after 30 seconds when any of the doors are opened and closed with the engine off. Lights may also be turned off by pushing lock button on remote.

-Daytime Running Light system (if equipped) Automatically turns on the headlights at a reduced intensity.

Turn signals

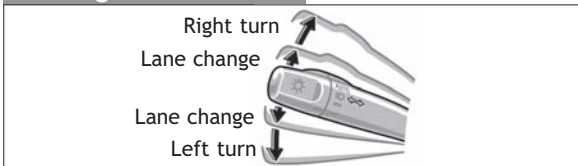

Front fog lights (if equipped)

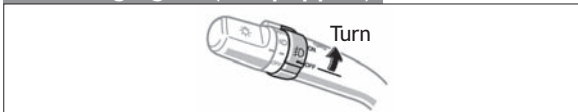

Front fog lights turn ON only when the headlights are on low beam.

Headlight beam level control (if equipped)

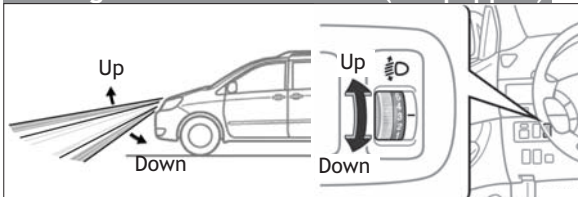

Higher number will lower the beam.

Window wiper & washer

Front

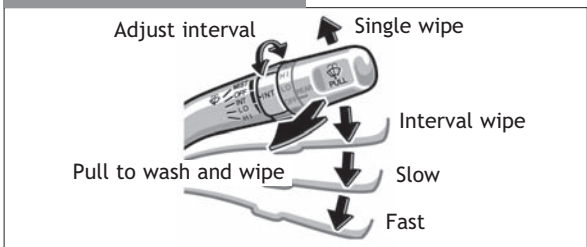

Rear

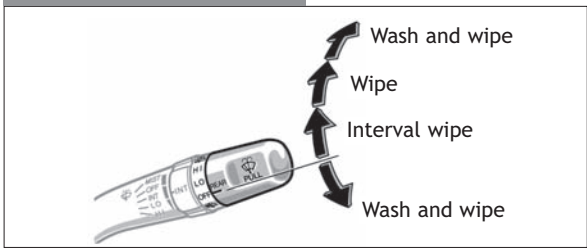

Parking brake

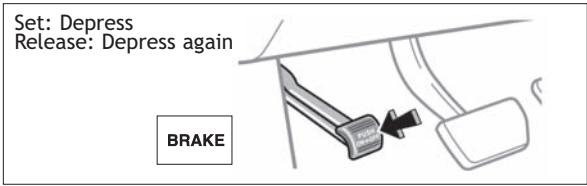

Windows-Power quarter (if equipped)

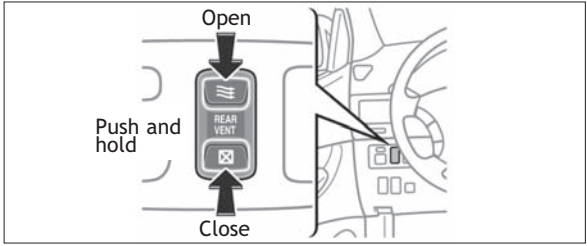

Windows

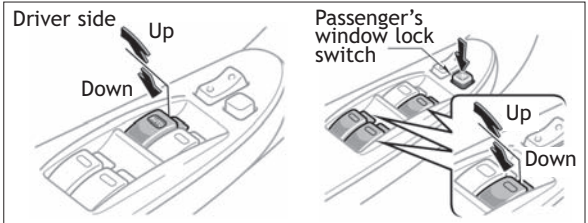

Automatic operation* (Driver side only) Push the switch completely down or pull it completely up and release to fully open or close. To stop window midway, lightly push the switch in the opposite direction.

NOTE: If battery is disconnected, the windows need to be reinitialized. Refer to the *Owner's Manual* for more details.

*If equipped

Moonroof (if equipped)

Sliding operation

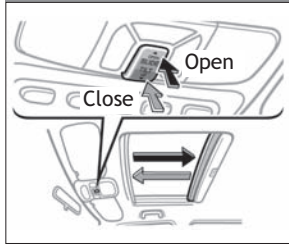

Tilting operation

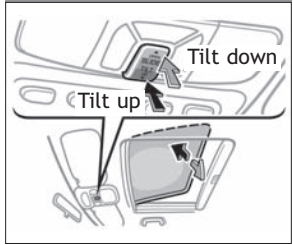

NOTE: If battery is disconnected, the moonroof needs to be reinitialized. Refer to the *Owner's Manual* for more details.

Seat heaters (if equipped)

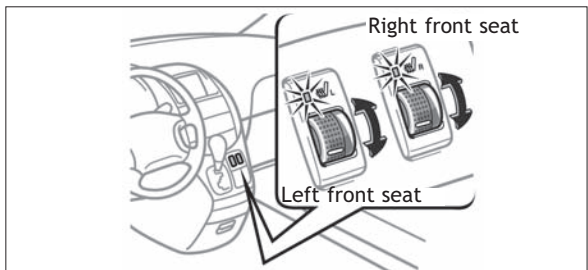

Doors-Power sliding (if equipped)

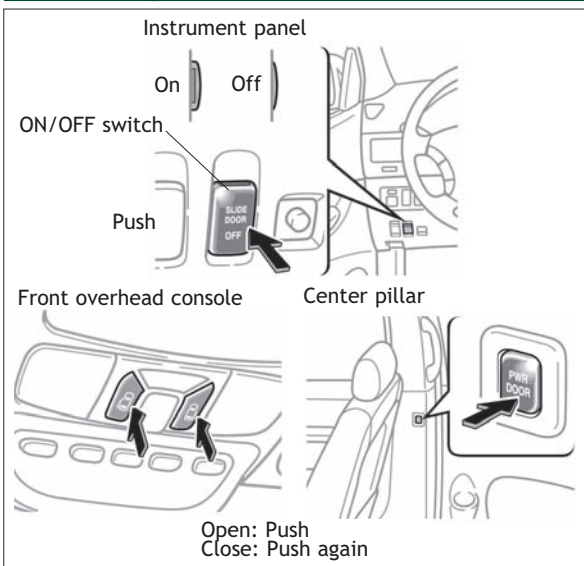

NOTE:

- When the key is in the “ON” position, power sliding doors will open only when gear selector is in the “P” Park position, and doors are unlocked. Refer to the *Owner’s Manual* for more details.
- An alarm will sound if a sliding door is open and the vehicle is shifted out of park.
- If battery is disconnected, the power sliding doors need to be reinitialized. Refer to the *Owner’s Manual* for more details.

Door-Power back (if equipped)

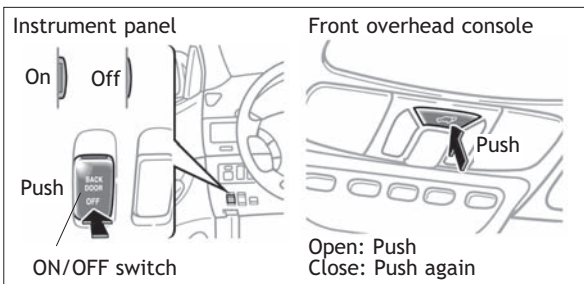

NOTE: If battery is disconnected, the power back door needs to be reinitialized. Refer to the *Owner’s Manual* for more details.

Console box (if equipped)

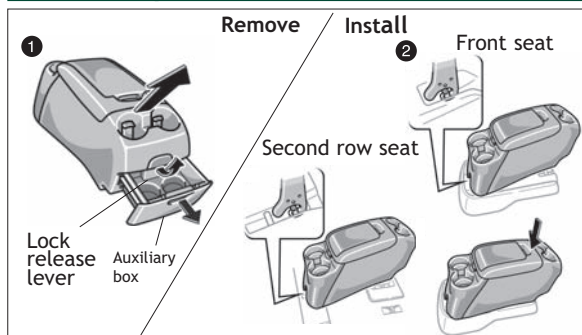

The console box can be removed and installed between the front or second row seats.

- 1 To remove Open the auxiliary box on the rear side, and pull the lock release lever. Lift the box from the rear to release it from the hook.
- 2 To install Place the hook into the striker. Lower box and push down to engage the rear lock.

Front seat console table (if equipped)

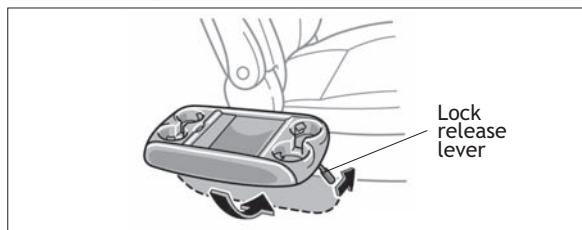

Clock

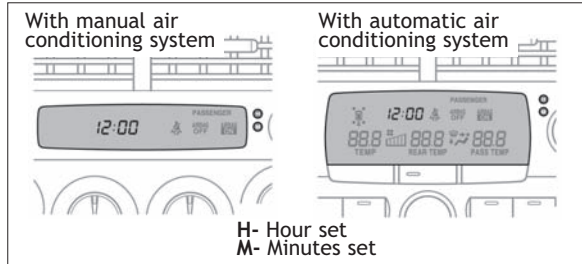

Seat adjustments-Front

Manual Seat



Power Seat

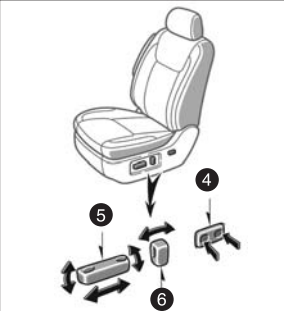

- 1 Position
- 2 Height crank (driver side only)
- 3 Seatback angle
- 4 Lumbar support (driver side only*)
- 5 Position, cushion angle and height
- 6 Seatback angle

*If equipped

Seat adjustments-Rear

Second row seat



Third row seat

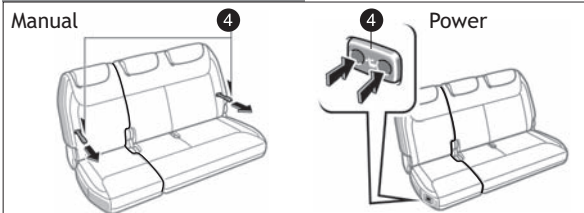

- 1 Position
- 2 Seatback release (from second row seat)
- 3 Seatback release (from third row seat)
- 4 Seatback angle

Refer to the *Owner's Manual* for more details.

Seats-Head restraints

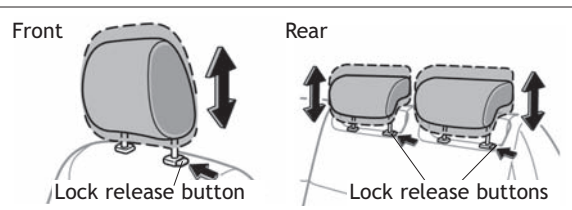

Seat arrangements (examples)

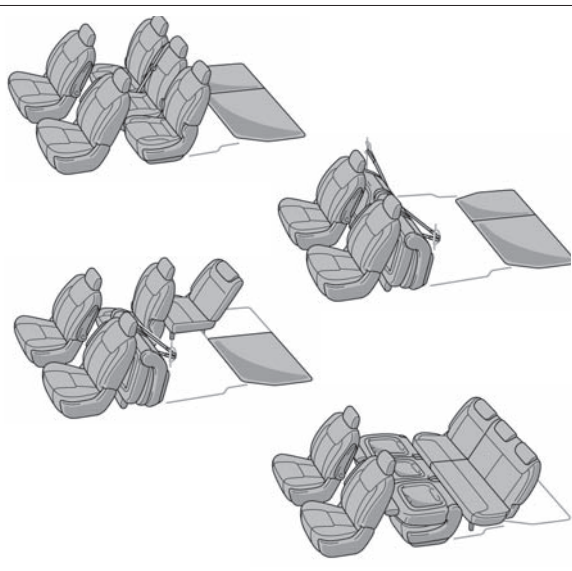

These are some possible seat arrangements. Please read the following section and refer to the *Owner's Manual* for more information about seat positions.

7-passenger models



8-passenger models



7-passenger models The right seat can be placed in the inside or outboard position.

8-passenger models The center seat can be placed in the forward position or even with the other seats.

Seats-Tumble/Remove second row seats

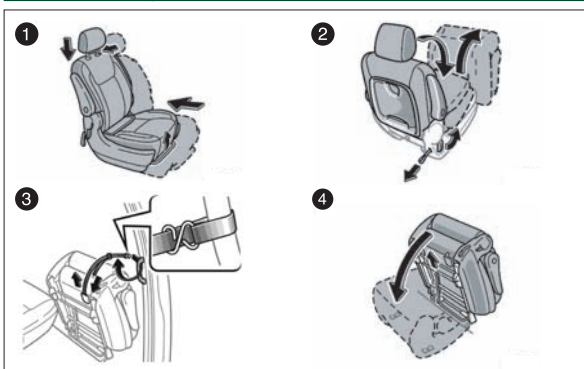

- 1 Lower the head restraint and slide the seat to the rear-most locked position.
- 2 Pull the strap or lever and tumble the seat.
- 3 Pass the strap through the assist grip.
- 4 Pull and hold the strap, then fold down the seat to disengage from front hooks.

Seats-Stowing third row seats (Manual)

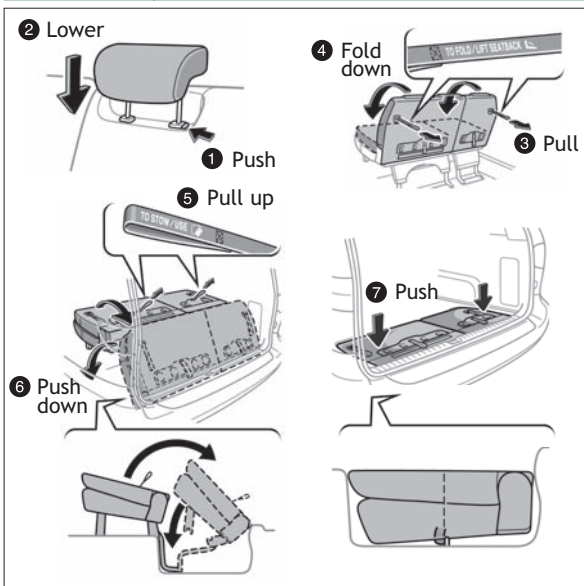

Seats-Stowing third row seats (Power)(if equipped)

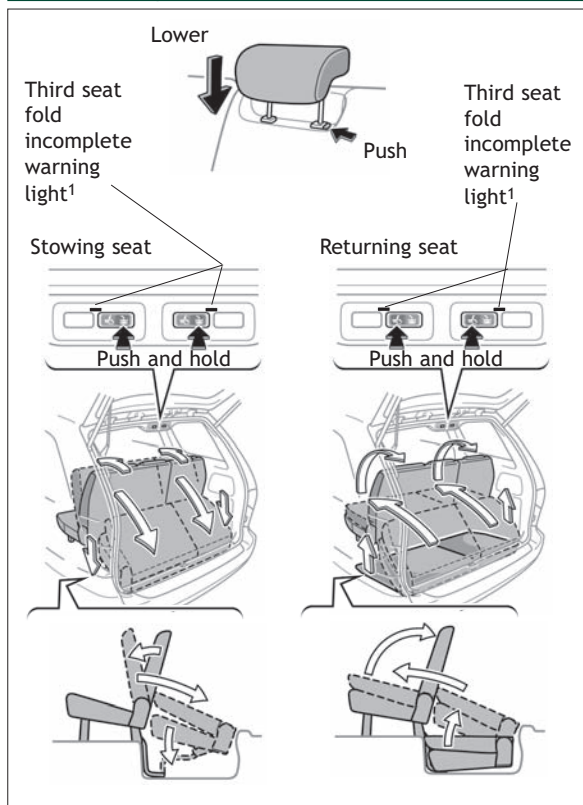

¹ This light will remain "ON" until the seat is fully open or stowed.

An alarm will also sound for 10 seconds, and the **3RD SEAT** indicator will light up on the instrument panel.

Refer to the *Owner's Manual* for more details.

Sunshade-Side (if equipped)

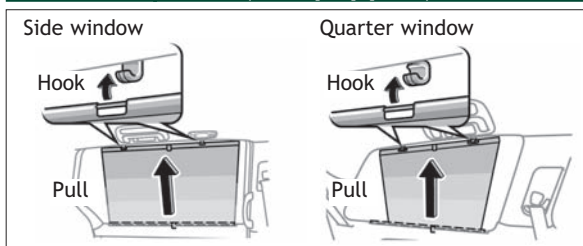

Cruise control (if equipped)

System ON/OFF

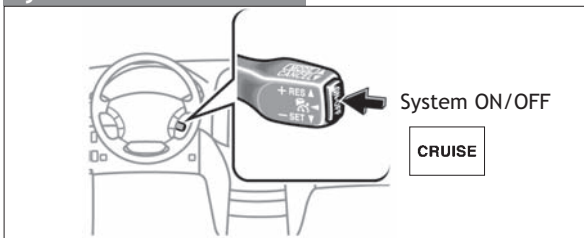

Functions

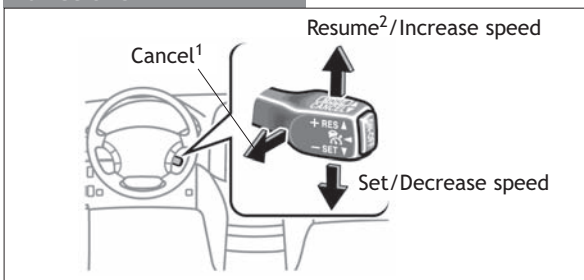

¹ The set speed may also be cancelled by depressing the brake pedal.

² The set speed may be resumed once vehicle speed reaches 25 mph.

Dynamic laser cruise control (if equipped)

Refer to the Owner's Manual for more details and complete safety precautions before attempting to use the "Dynamic laser cruise control."

Fixed speed mode

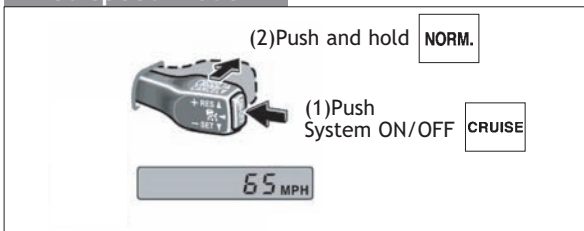

To set, cancel and resume a speed Refer to "Functions" in the *Cruise Control* section above, and the *Owner's Manual* for more details.

Distance control mode

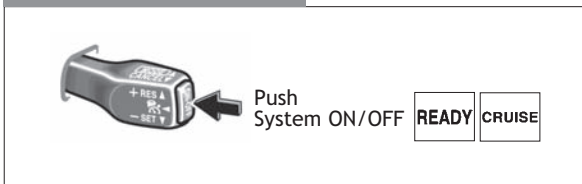

The distance control mode will cruise at a set speed, decelerate to maintain a selected distance from a slower vehicle in front of you, and accelerate back up to the selected speed if the vehicle in front of you changes lanes or speeds up.

To set, cancel and resume a speed Refer to "Functions" in the *Cruise Control* section at left, and your *Owner's Manual* for more details.

NOTE: Once vehicle speed is set, pushing lever up toward "+ RES." will increase speed to the nearest 5 mph, and then in 5 mph increments. Pushing lever down toward "- SET" will reduce speed in the same way.

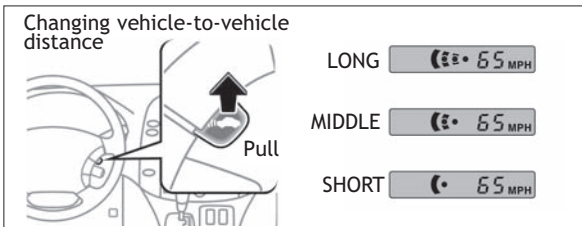

Light control-Instrument panel

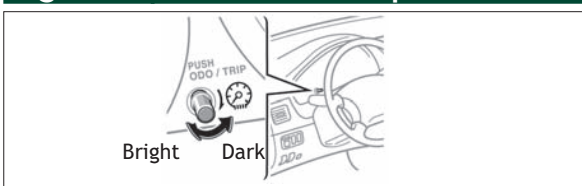

Audio

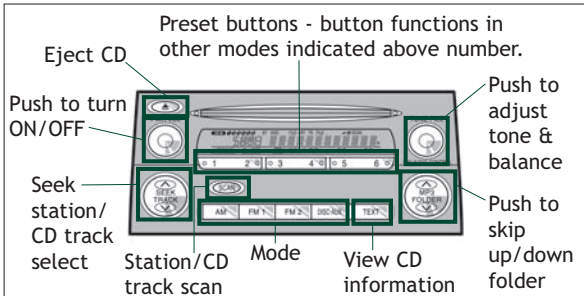

Type 2 functions include:

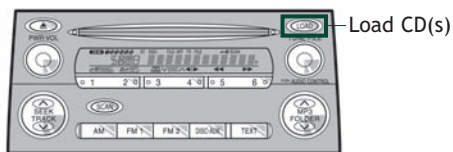

RADIO

Preset buttons Tune in the desired station and hold down a preset button (1-6) until you hear a beep.
"SCAN" Push and hold "SCAN" to scan preset stations.

CD PLAYER

To scan tracks on a disc Push "SCAN." Push again to hold selection.

CD Changer (Type 2 only)

-To load one disc Push "LOAD" and insert 1 disc.
 -To load multiple discs Push and hold "LOAD" until you hear a beep. Insert one disc. Shutter will close and then re-open for next disc.

To select a file (MP3/WMA only) Turn "TUNE·FILE" to file up/down.

To select a folder (MP3/WMA only) Push either side of "MP3/FOLDER."

Steering wheel switches (if equipped)

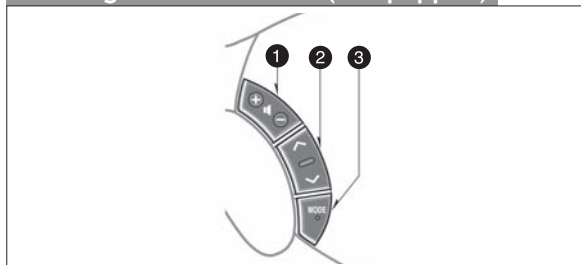

- 1 " - + " Volume control
- 2 " ^ v "
 - In radio mode Push to select a preset station, push and hold to seek the next strong station.
 - In CD mode Push to skip up or down to the next or previous track.
- 3 "MODE" Push to turn audio "ON" and select an audio mode. Push and hold to turn the audio "OFF."

AUX adapter

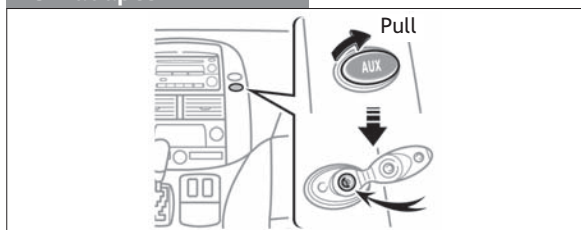

By inserting a mini plug of a commercially available component into the AUX adapter, you can listen to music from a portable audio device through the vehicle's speaker system.

Air conditioning/Heating

To reduce air flow from side vents, turn fan speed to OFF and recirculate cabin air, or close vent manually.

Front manual air conditioning

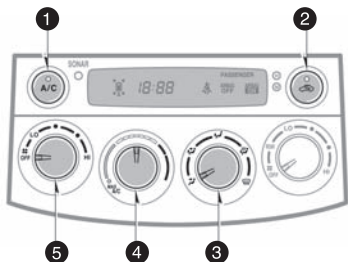

- ① Air Conditioning ON/OFF
Use fresh air to quickly cool interior, then change to recirculate for cooler air.
- ② Fresh or recirculate cabin air
- ③ Air flow vent selector
In “” or “” mode, use fresh air (“” indicator ON) to reduce window fogging.
- ④ Temperature
- ⑤ Fan speed

Rear manual air conditioning

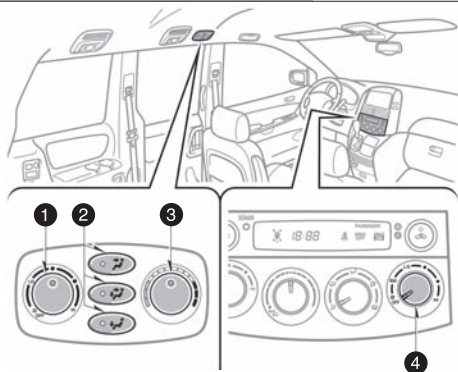

- ① Fan speed (rear)
- ② Air flow vent selector
- ③ Temperature
- ④ Fan speed (front)

Front automatic air conditioning

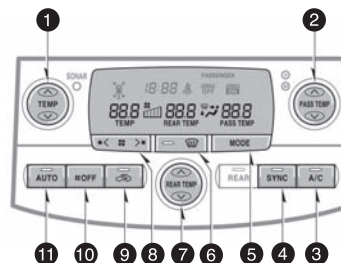

- ① Temperature (driver side)
- ② Temperature (front passenger side)
- ③ Air Conditioning ON/OFF
- ④ Synchronizes front and rear setting
- ⑤ Air flow vent selector
In “” or “” mode, use fresh air (“” indicator ON) to reduce window fogging.
- ⑥ Windshield air flow/defogger
- ⑦ Temperature (rear passenger side)
- ⑧ Fan speed
- ⑨ Fresh or recirculate cabin air
- ⑩ Climate control OFF
- ⑪ Automatic climate control ON/OFF

Rear automatic air conditioning

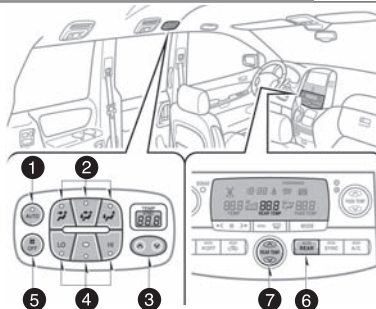

- ① Automatic climate control ON/OFF
- ② Air flow vent selector
- ③ Temperature selector (rear)
- ④ Fan speed
- ⑤ Climate control OFF
- ⑥ ON/OFF switch
- ⑦ Temperature selector (front)

Rear seat entertainment system (if equipped)

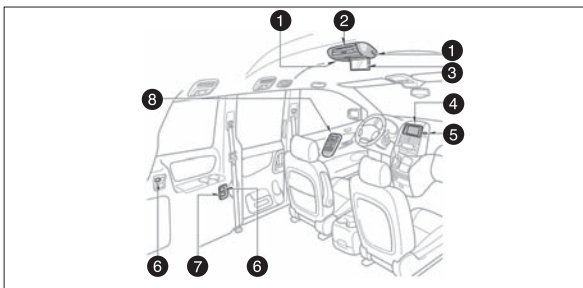

- ① Headphone jacks and headphone volume control
- ② DVD player
- ③ DVD screen
- ④ Front audio
- ⑤ 115V AC Power outlet ON/OFF switch
- ⑥ 115V AC Power outlets
- ⑦ AV input adapter
- ⑧ Remote control

Multi-Information display (if equipped)

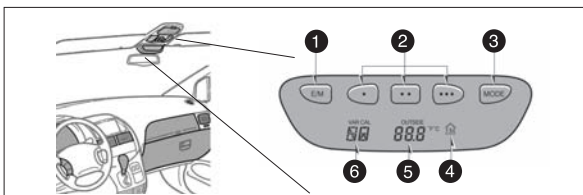

- ① Select standard or metric
- ② **Garage door opener buttons** Garage door openers manufactured under license from HomeLink®* can be programmed to operate garage doors, estate gates, security lighting, etc.

Refer to the *Owner's Manual* for more details. For programming assistance, contact the Toyota Customer Experience Center at 1-800-331-4331, or visit <http://www.homelink.com>

- ③ Change display information
- ④ Garage door opener indicator
- ⑤ Information display
- ⑥ Compass

*HomeLink® is a registered trademark of Johnson Controls, Inc.

Power outlets

12V DC

Instrument panel



Luggage compartment



Key must be in the "ON" position to be used.

115V AC (if equipped)

Beside second row seat

ON/OFF switch



Beside third row seat



Key must be in the "ON" position to be used.

Bottle holders

Front doors

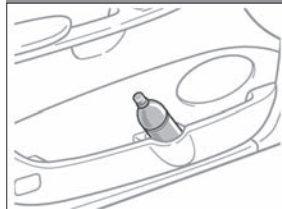

Sliding doors



Note: Do not place open containers in the sliding door bottle holders.

Cup holders

Instrument panel

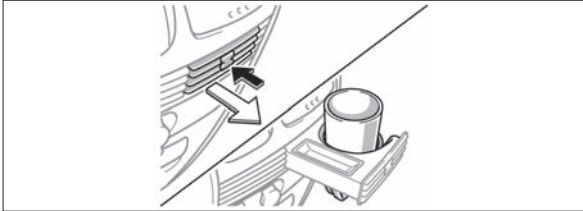

Front side table

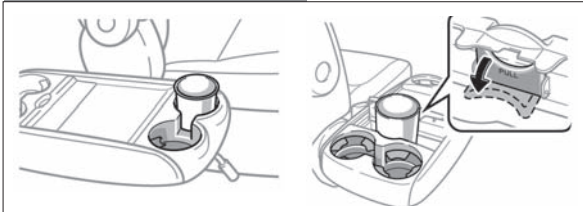

Quarter trim

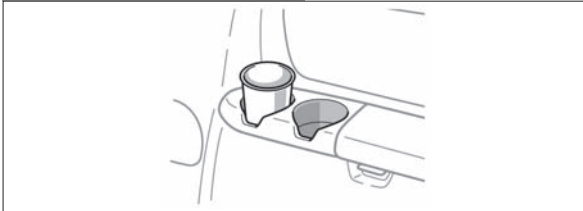

Rear console box

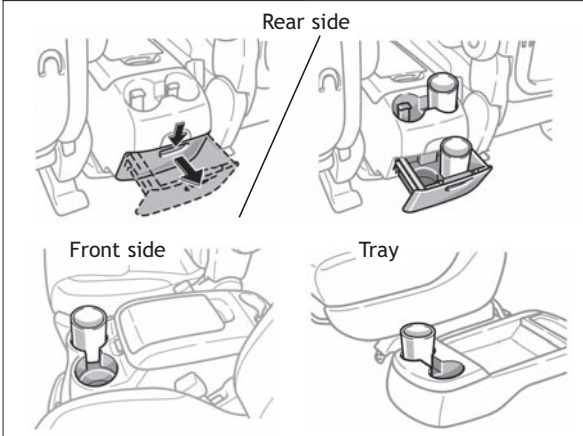

SAFETY AND EMERGENCY FEATURES

Door locks

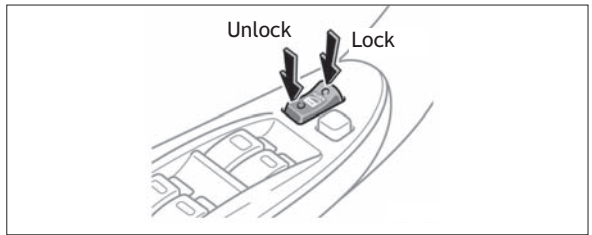

Doors-Child safety locks

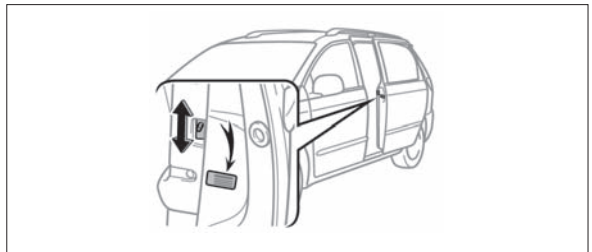

Move the lever to "LOCK," allowing the sliding door to be opened only from the outside.

Seat belts-Shoulder belt anchor

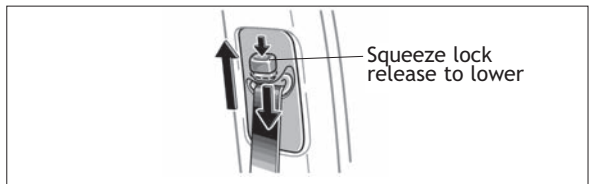

Squeeze lock release to lower

Seat belt comfort guide

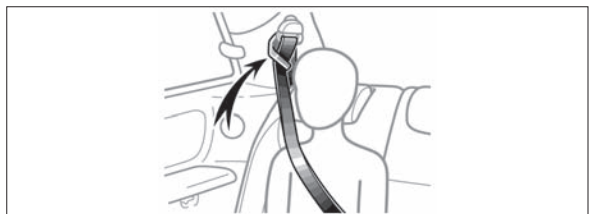

SAFETY AND EMERGENCY FEATURES

Seat belts

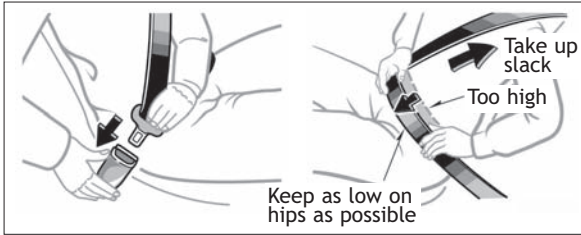

If belt is fully extended, then retracted even slightly, it cannot be re-extended beyond that point, unless fully retracted again. This feature is used to help hold child restraint systems securely.

To find more information about seat belts, and how to install a child restraint system, refer to the *Owner's Manual*.

Tire Pressure Warning System reset

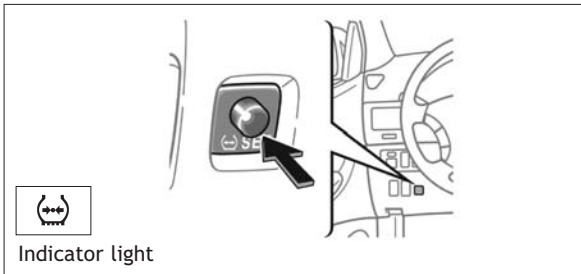

Designed to provide warning when tire pressure of any one of the tires is critically reduced while the vehicle is moving. It must be re-initialized by pushing and holding the "SET" button if indicator light blinks twice every second, and/or after replacing or rotating tires or wheels.